

**MICRO VANE PUMP
60 WATT MOTOR
G1/8 (BSPP) PORTS
WITH RELIEF VALVE**

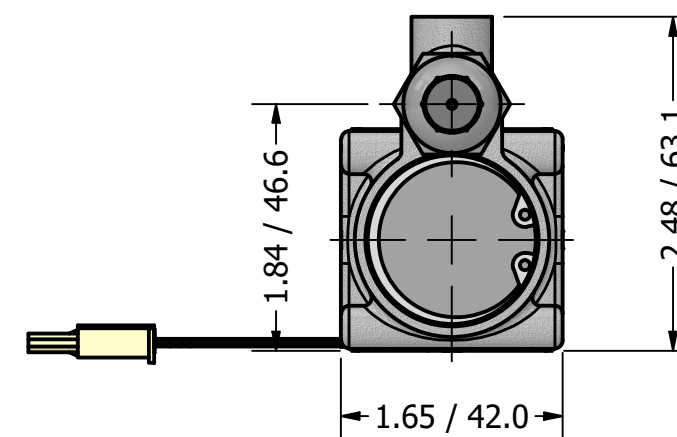
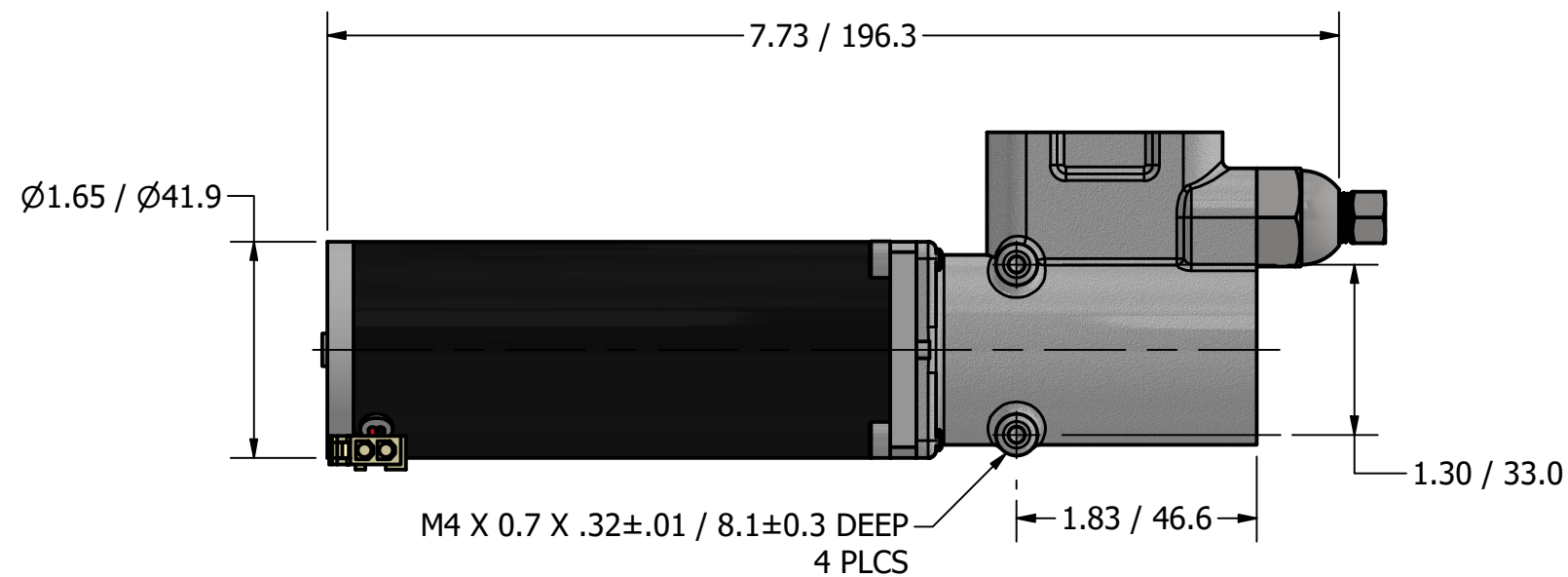
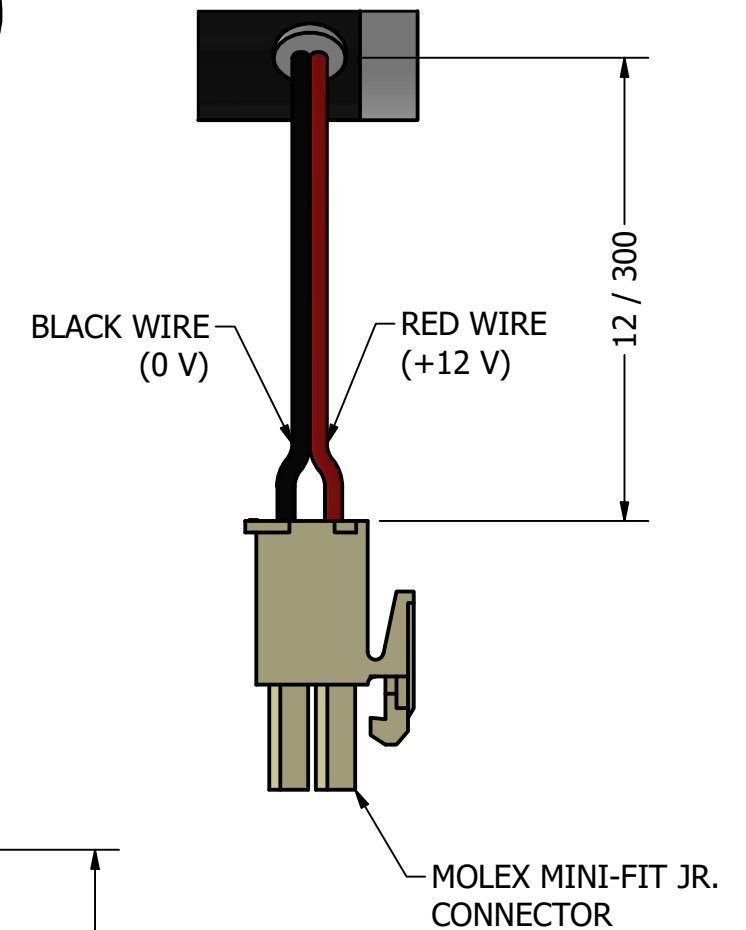
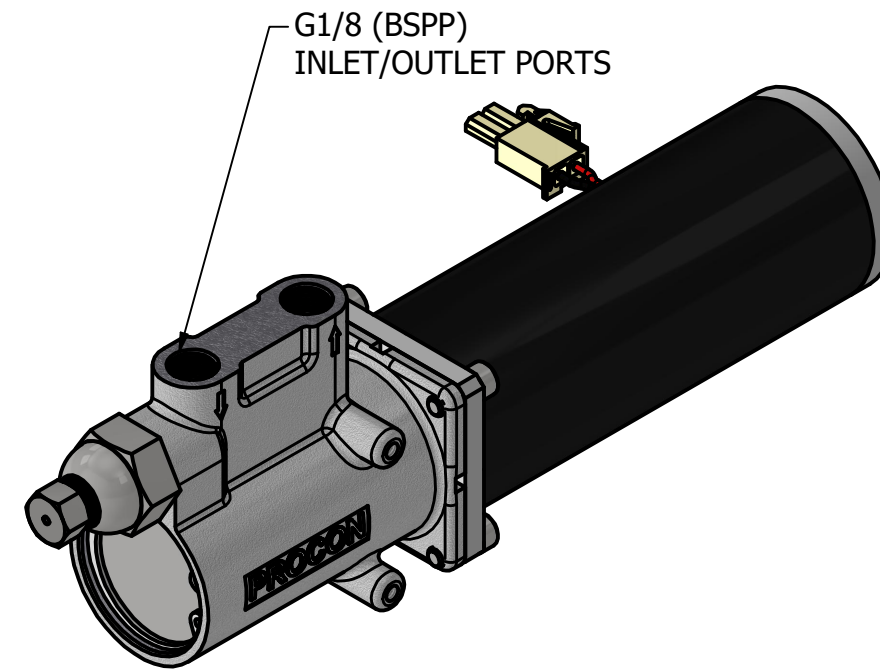
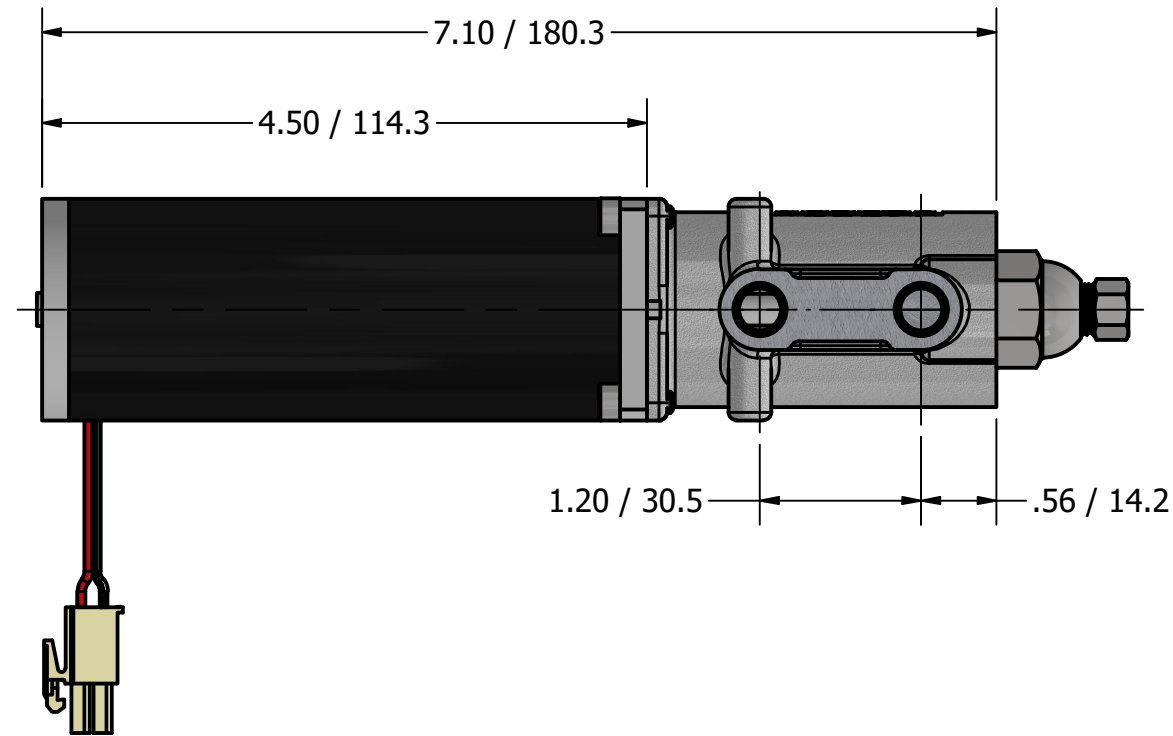

PROCON[®]
custom | fluid | solutions[®]

a division of **Standex**

W6016