

**SERIES 2
MAG DRIVE PUMP
125 WATT MOTOR
3/8" NPT PORTS
WITH RELIEF VALVE**

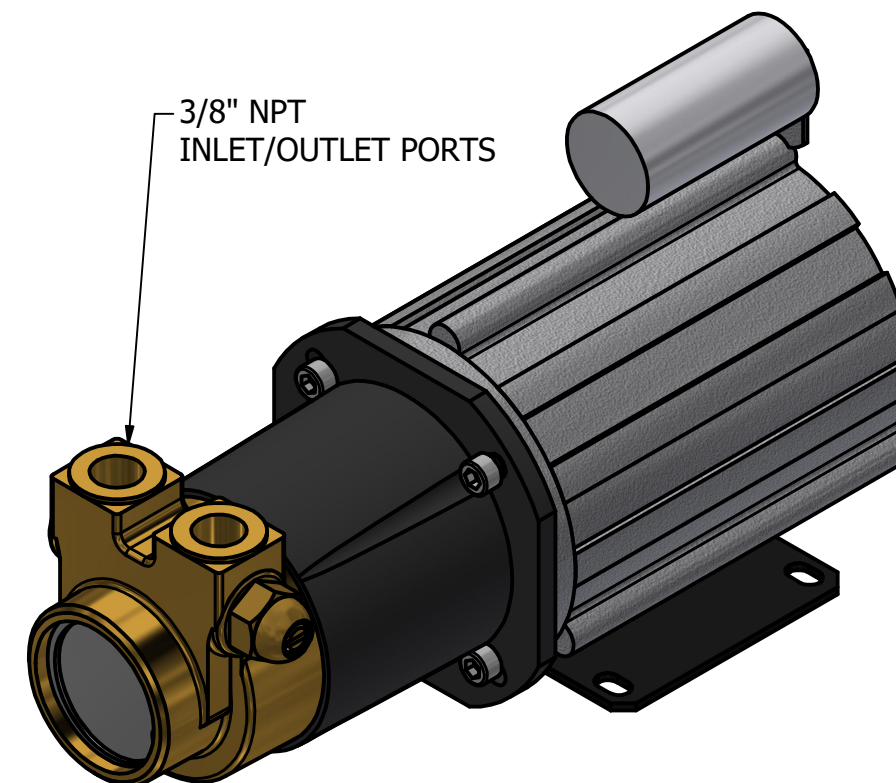
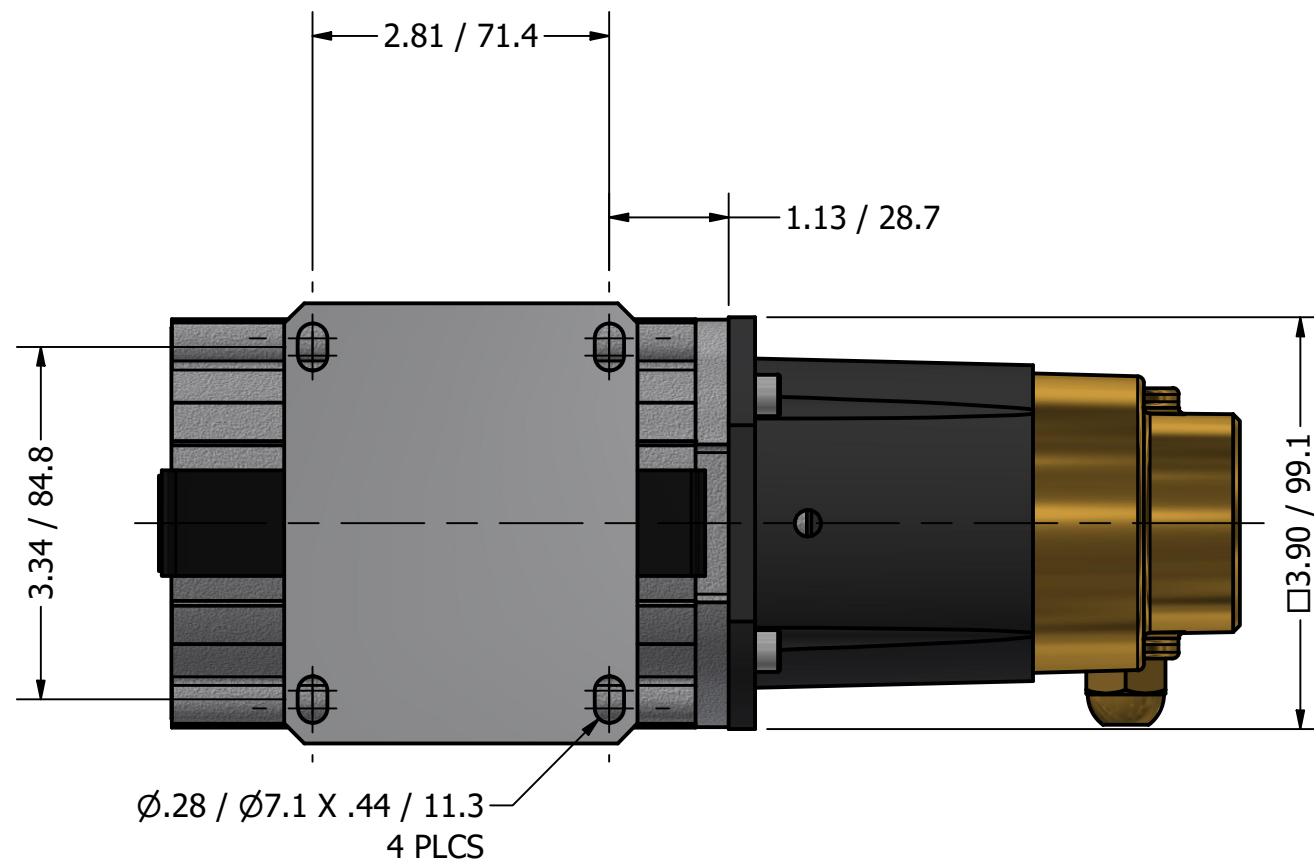
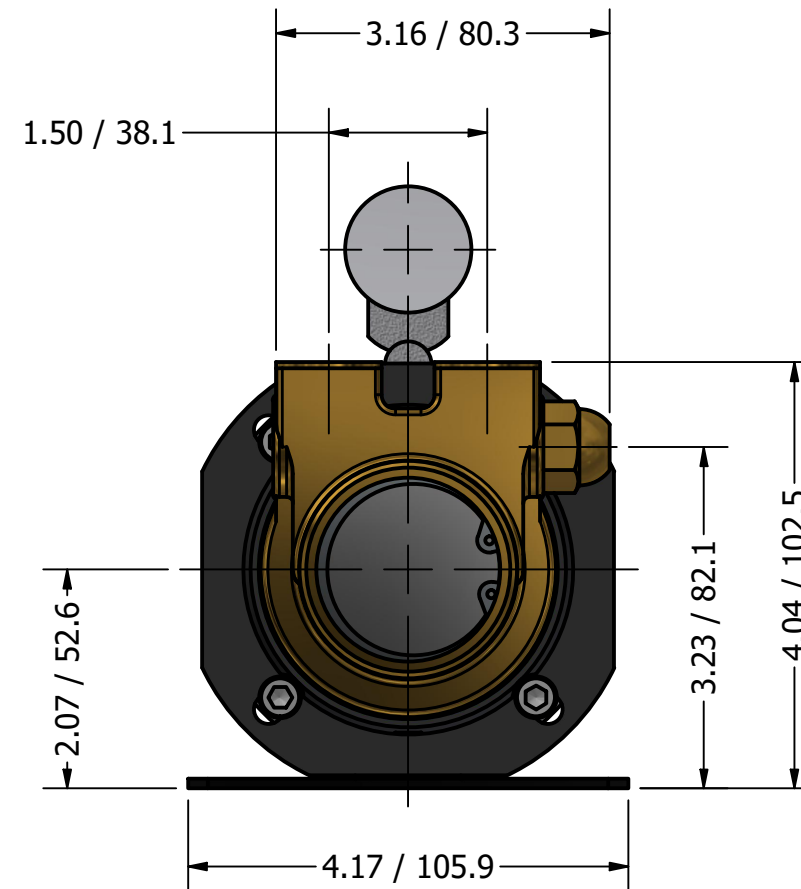
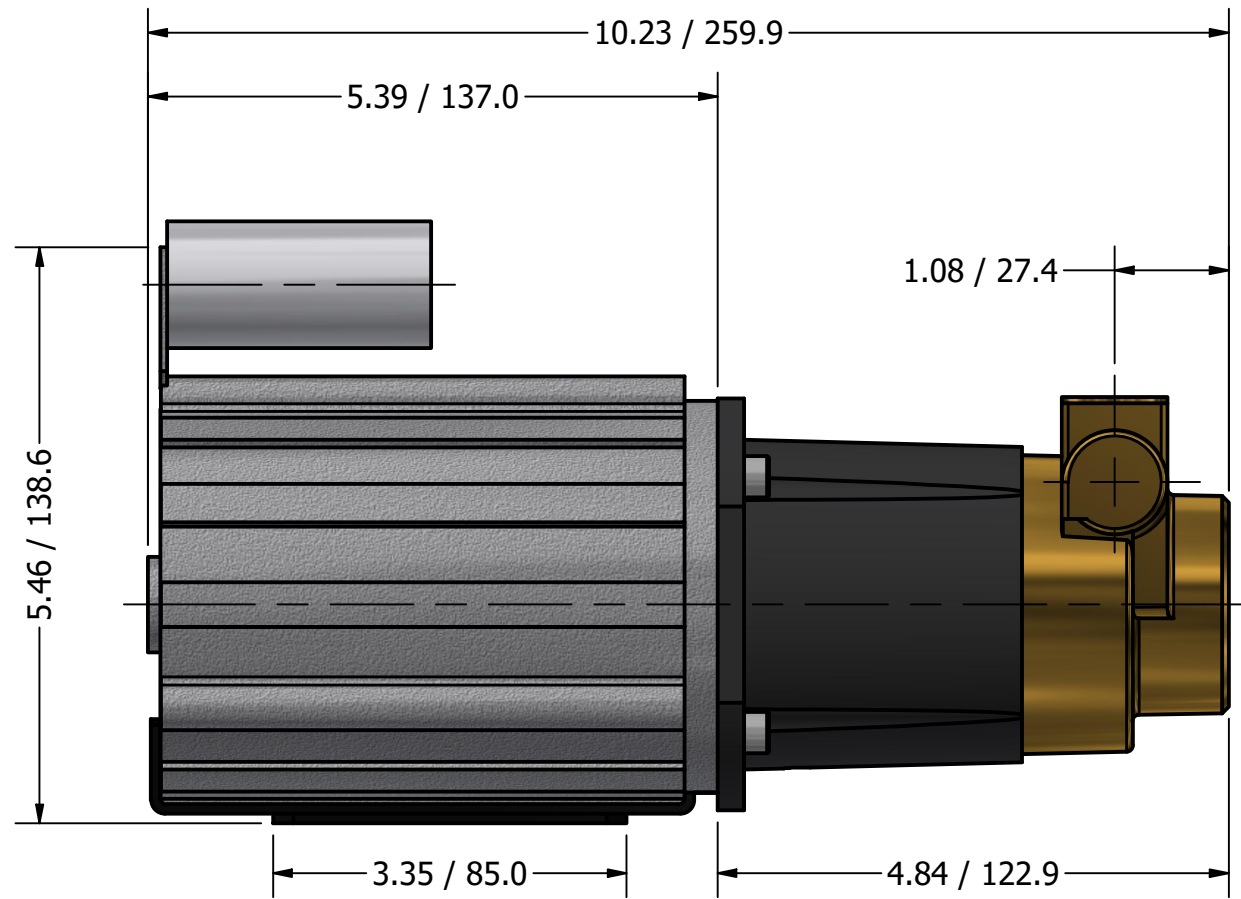

PROCON[®]

custom | fluid | solutions[®]

a division of **Standex**

W3020