

**MICRO VANE PUMP
80 WATT MOTOR
G1/8 (BSPP) PORTS
WITH RELIEF VALVE**

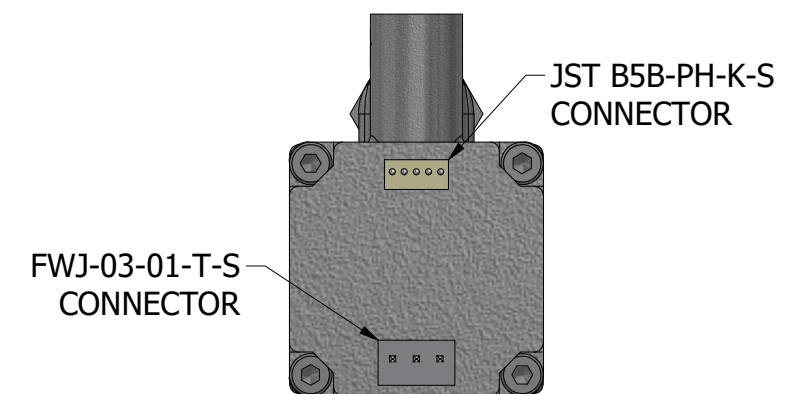
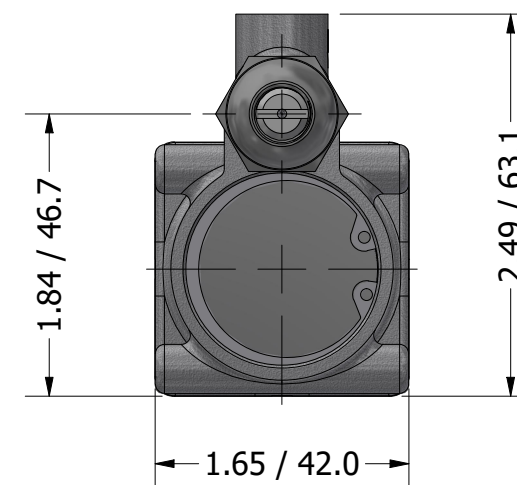
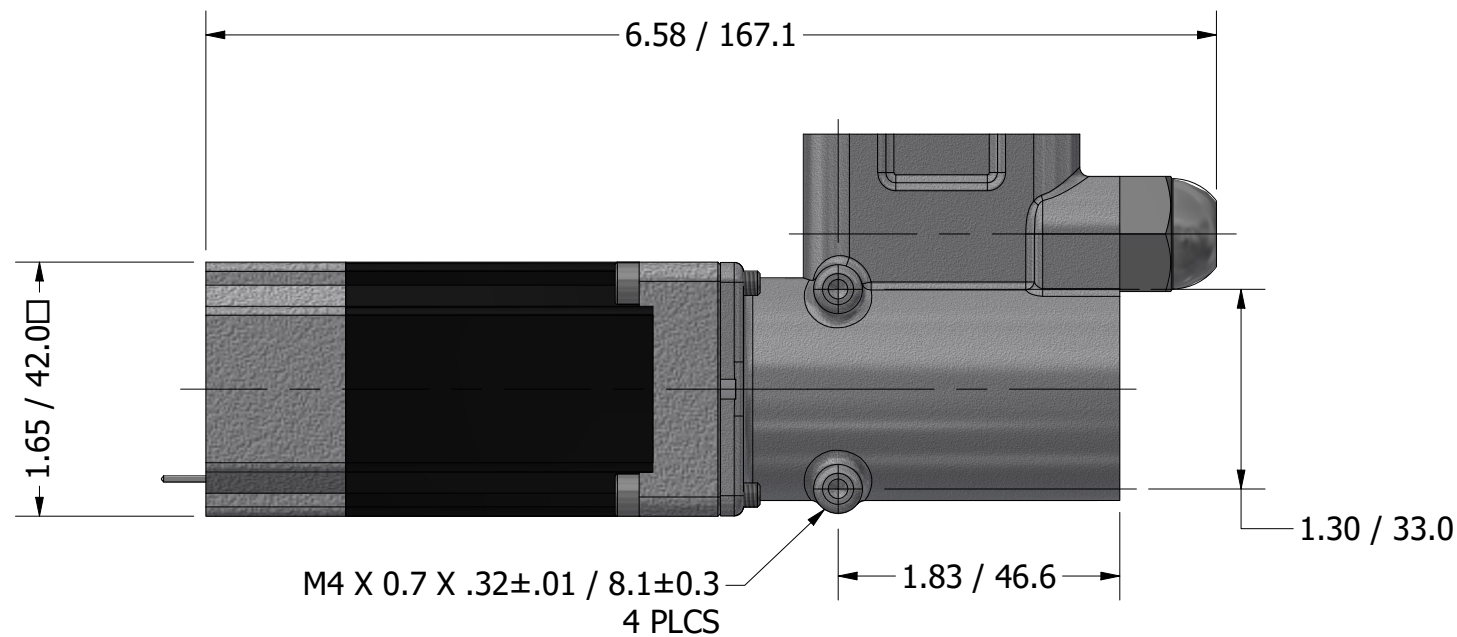
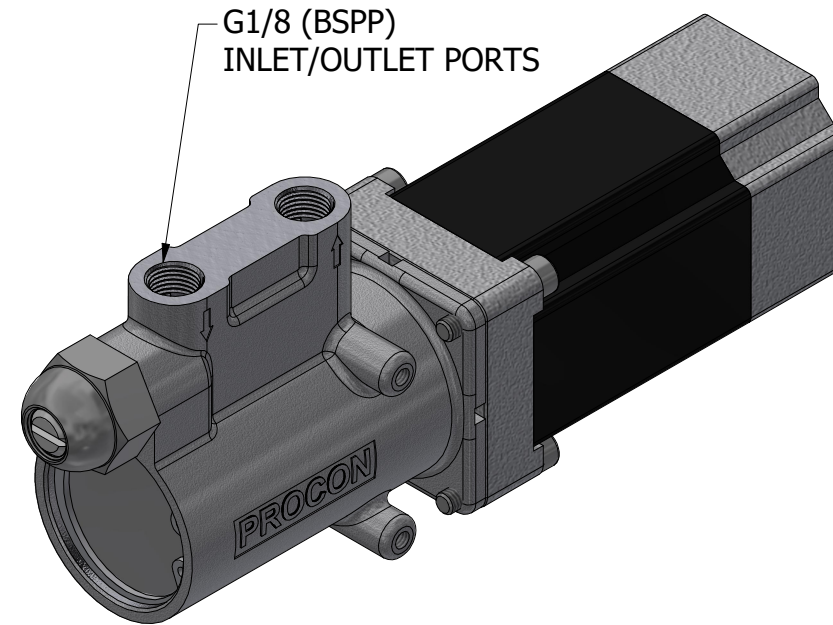
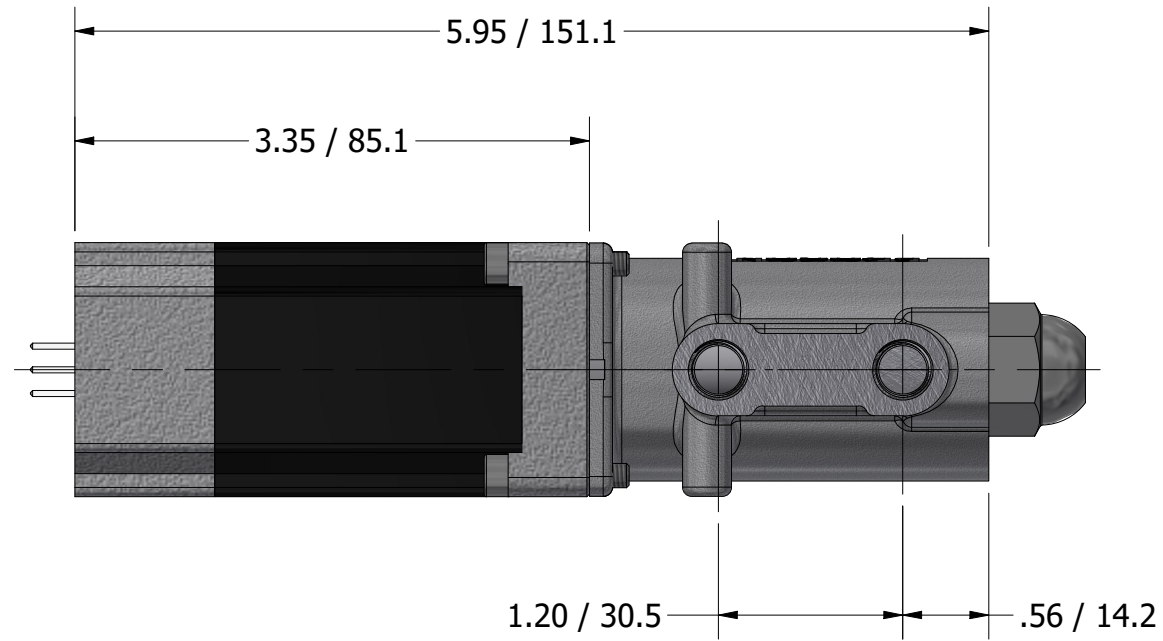

PROCON[®]

custom | fluid | solutions[®]

a division of **Standex**

W6004