

# MICRO GEAR PUMP 40 WATT MOTOR G1/8 (BSPP) PORTS

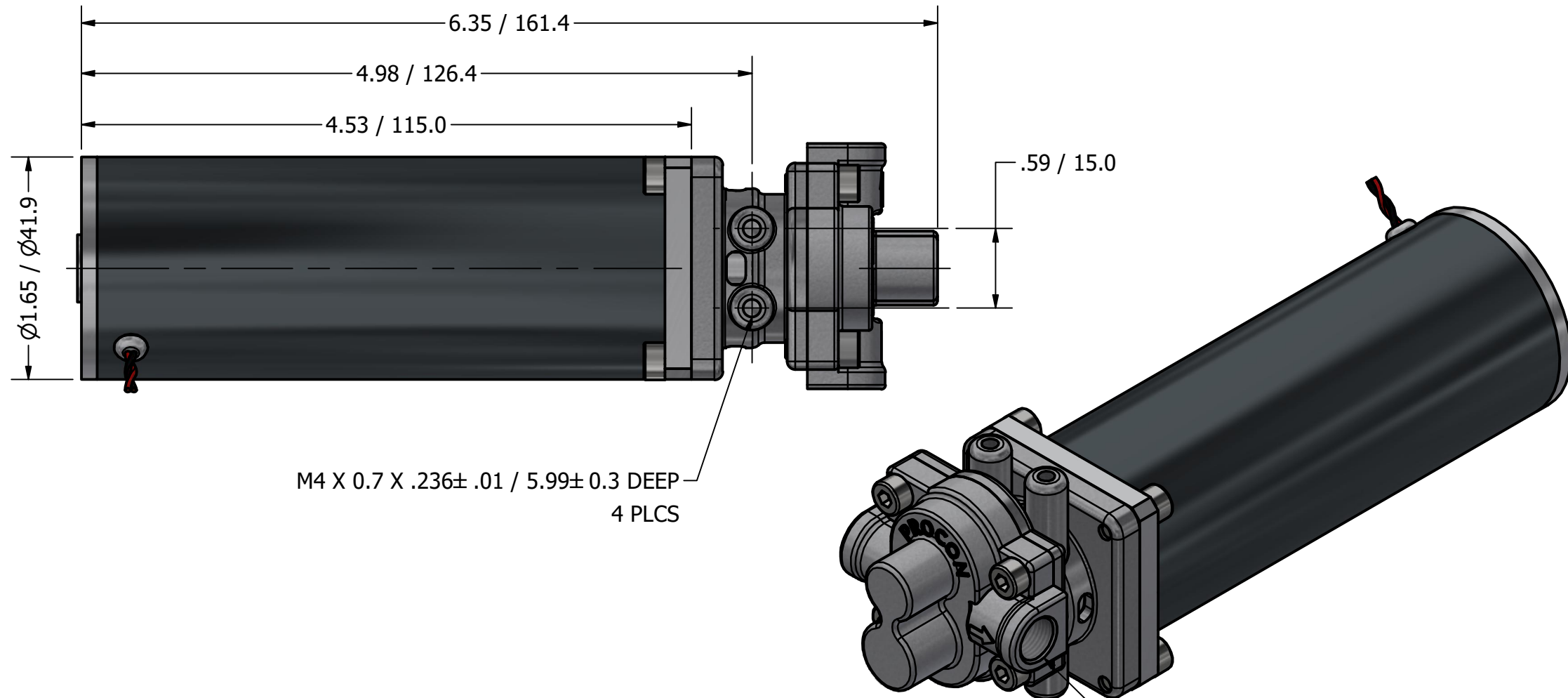

M4 X 0.7 X .236± .01 / 5.99± 0.3 DEEP  
4 PLCS

G1/8 (BSPP)  
INLET/OUTLET PORTS

